

LTL ACORN®

4K 30FPS Ultra-high-definition video

Ltl-8830 Series

5G NR or 4G LTE Cellular Mobile Communication

Low Power Consumption Infrared Scouting Camera

0.4S Trigger Time



USER'S MANUAL

TABLE OF CONTENTS

General Information.....	1
1.1 Features	2
1.2 Application	3
1.3 Illustration.....	3
1.4 Keypad	6
Getting Started	8
2.1 Load Batteries	8
2.2 Insert SD Card.....	8
2.3 Insert SIM Card	9
2.4 Insert the external button control box with display screen.....	9
2.5 Enter Test Mode	10
2.6 Automatic Infrared Sensing Shooting.....	11
2.7 Set up and install the environmental data acquisition device.....	11
2.8 Automatically Update Camera Time	13
2.9 GPS Positioning and Time Synchronization	13
ADVANCED SETTINGS	15
3.1 Set up Parameters on Camera	15
3.2 Playback Mode (Manual Send)	19
3.3 Set up Wireless Network Menu on Camera	20
3.4 Set up Camera on PC	24
3.5 SMS Remote Control & Table of Command Code.....	27
3.6 View Local MPNO Name and Signal Strength on TFT Screen.....	31
Set up Schedule on Computer	33
E-mail Uploading Function.....	34
4.1 Setup E-mail Parameters on Camera	35
4.2 Set up E-mail Parameters on PC.....	35
FTP Uploading Function.....	41
5.1 Setup FTP Parameters on Camera	41
5.2 Set up FTP Parameters on PC	42
SFTP Uploading Function	47
5.1 Setup SFTP Parameters on Camera	47
5.2 Set up SFTP Parameters on PC.....	47
Ltl Camera Cloud System Settings.....	50
6.1 Set Parameters of Ltl Camera Cloud System on Camera	50
6.2 Set Parameters of Ltl Camera Cloud System on Computer.....	51
6.3 Ltl Camera Cloud System Remotely Modifies Camera Parameters	55

6.4	Ltl Camera Cloud System Introduction	57
LTL-8830 Series Products		59
7.1	Ltl-8830 series model	59
IMPORTANT INFORMATION		61
8.1	Power Supply	61
8.2	Prevent From Short-Circuits	61
8.3	SD Card	61
8.4	Auto Adjustment on Video Length	61
8.5	850nm and 950nm IR LED	62
8.6	Mount on Tripod	62
8.7	FAQs on 4G Function	62
8.8	Low Battery Alert	63
Precautions		64
9.1	Battery safety	64
9.2	Use Camera Outdoors	64
FIRMWARE UPGRADES		66
Remote update program via Ltl Camera Cloud System		68
LIMITED WARRANTY		71
Appendix I: TECHNICAL SPECIFICATION		72
Appendix II: PACKAGE CONTENTS		75
Appendix IV: Place and Install Camera		76

Ver: Ltl-8830-EN-003

General Information

The manual is for model Ltl-8830W-5G, Ltl-8830-5G, Ltl-8830W-4G, Ltl-8830-4G, Ltl-8830WMC and Ltl-8830MC. This series cameras are 4K ultra-high-definition video 5G NR (4G LTE and no network version are available for option) cellular mobile communication camera, developed by our company, which equipped with external display.

Ltl-8830 series cameras use a high-end image processor, work with a 8 megapixels BSI CMOS image sensor and a 120 degrees wide-angle lens (60 degrees lens models optional) that captures up to 4K 30fps HD video with audio and 20 megapixels high-definition photos, the delicate and clear image offers users different visual experience.

Equipped with 5G NR wireless transmission module, supports multi-band 5G network, compatible with multi-band of LTE FDD and LTE TDD, with characteristics of fast transmission speed, supports multiple bands, etc. The maximum uplink speed in the 5G network environment can reach 500Mbps (for 4G LTE wireless transmission module, maximum uplink speed is 50Mbps), 4K video and 20MP photo can be quickly sent to the user's E-mail, FTP, SFTP server, or directly uploaded to the Ltl Camera Cloud System. In order to save traffic flow, users can the camera to send thumbnail. The superior SMS remote control function supports to change camera parameters, get camera shooting and sending picture back by sending SMS remote control command to wireless module, make it convenient to operate.

Low-power PIR sensors with features of high sensing accuracy and sensitivity to avoid wrong shooting and missed shooting, as well as features of low standby current and so on when working on the camera. The camera standby current is about 90uA, far lower than 400 to 2000uA of other brands hunting camera in the industry, which greatly extends the standby time.

Ltl Acorn established the Ltl Camera Cloud System Server based on traditional wireless transmission products to offer users a better product experience. This system is a comprehensive network camera management system integrating camera image reception, image management, camera management, environmental data analysis and camera remote control. The captured picture and video can be directly uploaded to Ltl Acorn cloud system via network with protocol http/https, users are able to log in the cloud system on mobile APP, WeChat official account or computer web browser to view and manage the pictures and video uploaded by the camera, as well as remotely manage the camera, modify camera parameters, etc.

Please read the USER'S MANUAL in details before starting for better understanding and operation.

1.1 Features

- Starlight BSI CMOS 8MP image sensor (with Nyxe technology).
- 4K ultra-high-definition video recording with audio, video resolution 4K(3840x2160) and 2K(2560x1440) optional, video compression format H.265.
- Photo resolution 20MP, 16MP, 12MP, 8MP and 4MP optional.
- Shooting mode: video + snapshot mode, photo mode and video mode, (video+ snapshot mode: take a snapshot during video recording in ON mode, the size of the snapshot photo is consistent with the video resolution).
- 0.4s ultra-fast trigger speed to take video.
- Connect with the removable 2.45" external color display by Type-C socket, it's also easy to set up parameters, preview and playback video and photo after camera is installed.
- PIR detection distance 35 meters, sensing angle for shooting is 100 degrees.
- 120 degrees wide angle lens offers wide shooting range, photo is clear and delicate (60 degrees lens optional).
- 5G NR wireless transmission module, upload speed is up to 500Mbps (optional 4G LTE wireless transmission module version, maximum uplink speed is 50Mbps).
- Send video and photo over wireless network to E-mail, FTP, SFTP, or Lti Camera Cloud System.
- The GIS cloud system manages huge image and video data, presents on the large screen in the command center.
- Optional front-end server to adapt to the user's existing management system.
- Connect the external environmental data detector by the Type-C port, which accurately detects the ambient temperature, humidity and light intensity of the environment where the camera located, collect data automatically and upload the data to the Lti Acorn Cloud system at regular times every day.
- SMS remote control, text camera from mobile phone to change camera settings and trigger camera remotely.
- Standby time more than 3 years with 6x 18650 lithium batteries.
- Supports solar power to charge 6x 18650 batteries in the camera.
- Ultra-low standby current, about 90uA.
- Broadcast function, connect the speaker in ON mode to play sound/call while shooting.

- The maximum power of the speaker is 20W, the maximum volume exceeds 100db, built-in with 18650 lithium battery.
- Update camera time synchronously over the network.
- Support Beidou and GPS satellite positioning, automatically obtain coordinate of camera's current position and update it's clock.
- After GPS antenna installed, the camera can also be positioned in real time in ON mode, it's easy to know the camera position.
- 6 super bright IR LED lights for great night vision, 850nm, 950nm or white flash light available for option.
- Shooting date, time, biotope, latitude and longitude, battery level, temperature, moon phase, etc can be showed at photo stamp.
- Password protected to prevent unauthorized operation.
- Support 16GB~128GB (Cass10) SD card, memory overwrite function available for option.
- Working humidity:5% ~ 95%
- Working temperature:-45°C - +70°C
- Tight waterproof case structure, IP68 ingress protection.
- 5G wireless module supports frequency: n1/n28/n41/n77/n78/n79 (4G module doesn't support 5G frequency)
 LTE-FDD: B1/B2/B3/B5/B7/B8/B20/B28
 LTE-TDD: B34/B38/B39/B40/B41
 WCDMA: B1/B2/B5/B8
- 4G LTE wireless module supports frequency:
 B1/B2/B3/B5/B7/B8/B28B40/850/900/1800/1900MHZ

1.2 Application

- Wildlife animal and plants observation
- Security and surveillance

1.3 Illustration

- Figure 1.1 shows the front view of the camera
- Figure 1.2 shows the bottom view of the camera
- Figure 1.3 shows the camera's external button control box with display screen
- Figure 1.4 shows the camera's battery compartment

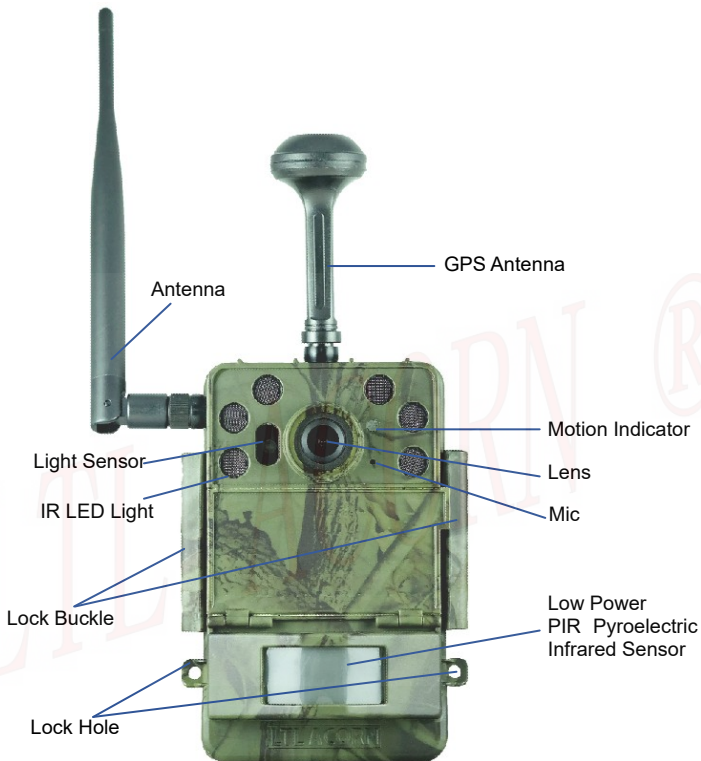

Figure 1.1 Front View of the Camera

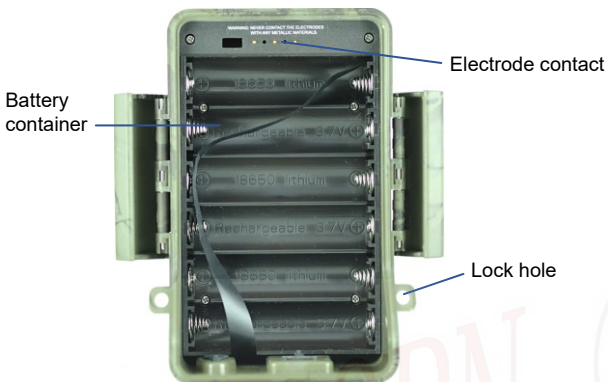

Figure 1.2 Bottom View of the Camera

The camera provides the following connections for external devices: Type -C port of external LCD display and keypad control box, SD card slot, SIM card slot, external DC power charging port. 2 positions of power mode switch: switch inward: OFF mode, switch outward: ON auto shooting mode. To enter TEST test mode, please connect the external display when the switch is at ON position, when the switch is at ON and unplug the external display, camera enters the automatic shooting mode.



• Figure 1.3 shows the camera's external button control box with display screen



• Figure 1.4 shows the camera's battery compartment

CAUTION: If you are not using the camera for an extended period of time, it is highly recommended that you remove the batteries from the camera to avoid possible acid leak that may damage the camera and void the warranty.

1.4 Keypad



Keypad

Keypad	Function
Power mode switch	OFF: power off. ON: automatic shooting. ON (connect with external button control box with display screen): enter test mode.
MENU key	Enter/exit menu.
Left key	Press to enter the wireless settings menu (TEST mode). Choose submenu setting item of menu (menu mode).

Right key	Take photo (camera mode). Take video (video mode). Exit play or stop recording video(replay mode)
Up arrow key	Enter video mode (TEST mode). Move upward (menu/replay mode).
Down arrow key	Enter camera mode (TEST mode). Move downward (menu/replay mode).
OK key	Confirm. Enter/exit reply mode.
Working indication light	The red light flashes 5 times when the camera enters the ON automatically shooting mode.
PIR indication light	In TEST mode, the indicator light is up when PIR detect the animal.

Getting Started

2.1 Load Batteries

The battery box on the back of the camera can load 6 18650 lithium batteries.



- Please note that the battery polarity should correspond to the marks on the battery box when installing.
- Please follow the positive and negative mark on battery box to load 6x18650 lithium batteries.

Note: When using the battery case to power the camera, please be sure to install 6 fully charged 18650 lithium batteries in the battery box.

The camera can use an external DC power supply of output current 2A, 12V~24V to charge the battery in the battery box. It is recommended to use our company's LTL-SUN-5.5W or LTL-SUN-9.5W solar panel (purchased separately) for long working time. The camera may work in the field for more than 3 years without replacing battery.

2.2 Insert SD Card

Support 16GB ~ 128GB (Class 10 and above), the genuine SanDisk or Kingston 32GB SD card (Class 10 or above) are recommended. Please format the SD card on camera before using it for the first time. Unlock the lock buckles and you will see the SD card slot at the bottom of the camera, insert SD card as below picture slightly into SD card slot, you will hear the sound like "click" and the card insertion is finished. Please make sure the SD card insertion direction is same with the sign aside the SD card slot.



Insert SD card

The camera does not come with internal memory. It will not work without a SD (Secure Digital) memory card or SDHC (High Capacity) card. Before inserting the SD card, please make sure the write-protect switch is at “OFF” side (NOT at the “LOCK” position), format the SD card on camera before using.

2.3 Insert SIM Card

SIM card should be purchased from local mobile operator and ensure that SMS and 5G or 4G data traffic are available.



Insert SIM Card

At the left side of the camera back, you can see the SIM sign and the SIM card slot. Insert the SIM card into the slot as the sign slightly and you will hear sound “click” and finish insertion. Please make sure the insertion direction of SIM card is correct when inserting.

2.4 Insert the external button control box with display screen







Turn the camera switch to the ON position to enter the TEST mode after it is normally connected to the external display. After the switch is turned to the ON, when there is no external display connected, it automatically enters ON mode.



There is a Type-C USB socket at the bottom of the camera main unit, insert the plug of external button control box with display screen into the socket and finish installation. The display cannot plug well if in opposite direction.

2.5 Enter Test Mode

Turn the switch to ON position, close the camera with the battery box and fasten the buckles (battery box with 6 fully charged 18650 batteries correctly installed), insert the Type-C USB plug of external display into camera as the picture, camera enters preview test mode. External button control box with display screen with the keypad, in this case, you can use the camera as a normal digital camera to take picture and video by controlling the keypad.

- Press  to take video (move upward in menu or replay mode).
- Press  key to set the camera to take pictures (press down arrow key in MENU or REPLY mode). Set the brightness of night picture in Camera mode.
- Press  **SHOT** key to manually take picture or video and save in SD card. Furthermore, press  **SHOT** key to play or stop playing video when replying.
- Press **OK REPLAY** key to enter Replay mode (confirmation function in menu mode). At this moment, press up and down arrow key to turn page.
- Press  **MENU** key to enter menu, change parameters setting to make the camera works as required. To change the camera parameters, please refer to the Advanced Settings for better operation.
- Press  key to enter the wireless settings menu, **please refer section 3.3 for details.**

In the Test mode, you can test the working area of the IR sensor, especially the sensing angle and the sensing distance. Do the following:

- First tie the camera to the tree with a strap and aim at the area you are interested in.
- Walk parallel to the camera from one end of the sensing area to the other. Try different distance and angle to the camera.
- If the indicator light is only flashing blue or red when you moving, indicating that camera will activate in advance at the location of you. If the indicator light is flashing red and blue at the same time, it means that the camera will take pictures at your position.

After doing this test, you can find the best shooting position when you install the camera. In general, we recommend placing the camera at a height of 3 to 6 feet (1 to 2 meters) from the ground.

2.6 Automatic Infrared Sensing Shooting

After load 6 fully charged 18650 lithium batteries, turn switch outwards to ON mode, close the camera unit with battery box and lock the buckles, when the working indicator light is flashing, it enters the ON mode by default to shoot automatically. After entering this mode, the red indicator light on the front of the camera will flash 5 times, after the red light is off, the camera enters the automatic shooting mode. When animal or other objects enter the sensing range of the PIR, the camera will immediately start recording picture or video.

Caution: To avoid potential false triggers due to temperature and motion disturbances, please do not aim the camera at a heat source (e.g.: the sun, heated stone or metal) or nearby tree branches and twigs. The ideal direction to aim at is the north and the open place without heat source.

2.7 Set up and install the environmental data acquisition device

External environmental data acquisition device is not included in standard package, it can be purchased separately. The Ltl Acorn environmental data acquisition box is a device that collects the temperature, humidity, light intensity, soil temperature and soil moisture of the surrounding environment. After it is connected to wireless communication trail camera, it can monitor environmental changes and record the environment data of temperature, humidity, light intensity, soil temperature and soil moisture.

Two models available: Ltl-WSD-01 and Ltl-WSDTR-01

Ltl-WSD-01: monitors and collects data of ambient temperature, humidity, and light intensity.

Ltl-WSDTR-01: monitors and collects data of ambient temperature, humidity, light intensity, soil temperature and soil humidity (with soil monitoring probe)



Lti-WSD-01



Lti-WSDTR-01

Note: Lti-WSDTR-01 with a soil monitoring probe, please insert the probe into the soil about 2.5cm deep when using (it can be adjusted appropriately according to the field environment), it can monitor the soil temperature and the relative humidity of the air in the soil.



The probe head is facing down when mounted

Install the external environmental data acquisition device

Camera connects external display to enter TEST mode after powering on, in TEST mode, set the send option to Camera Cloud System and set it' s upload parameters, set the environmental monitoring menu to 'On'. Unplug the external display after the menu setting is completed, camera enters ON mode, then connect the Type-C USB plug of environmental data acquisition device with camera as the picture correctly, it can start automatically collecting ambient temperature, humidity, light intensity and soil temperature

and humidity(collects every 5 minutes) and upload the data collected to the cloud system every 6 hours through the camera. The uploaded data can be viewed on page Ltl Camera Cloud System -> Environmental Data Analysis.

Attention: The Environment Monitoring only works when the sending status is set to the Ltl Camera Cloud System and the Environment Monitoring menu is "ON".

2.8 Automatically Update Camera Time

Automatically update the camera time over the network requires the camera with SIM card inserted to connect to network.

Connect the external display in ON mode to enter TEST mode, the wireless module receives the network signal and begins to update and correct the camera time, after the update is successful, the display shows 'UTC SUCCESSFUL'.

In ON mode, camera starts wireless module to connect to the network at about 00:13 every day to automatically update and correct the camera system time.

2.9 GPS Positioning and Time Synchronization

After the camera installed with GPS antenna and connected with external display to enter the TEST mode, it can automatically search and acquire the satellite signals from BeiDou, GPS, GLONASS and QZSS. Once the satellite signals acquired, the camera can obtain the location coordinates and time, and update them to the camera.

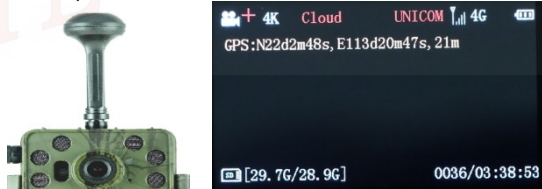

In the ON mode, the camera starts the GPS module at 00:13 every day to search for satellite signals and update the location coordinates and time.

Attention: GPS requires an unobstructed place where you can see the sky to receive satellite signals, dense forests or locations under buildings would severely affect the GPS to receive satellite signals. To ensure the good performance of GPS function, please install the

camera in an outdoor open area and avoid any obstructions above the camera as much as possible.

The camera connected to the 4G network with GPS antenna installed, setting the 4G sending parameters in TEST mode, switch camera to ON mode after location coordinates is obtained, when the camera is moved over 180 meters, it updates the latest coordinates every time when it shoots images at the updated coordinates to the user's email(email to send and receive GPS coordinates should be filled, **please refer to the section 3.3 latitude and longitude settings menu**).

LTL ACORN®

ADVANCED SETTINGS

3.1 Set up Parameters on Camera

LTL ACORN hunting cameras are shipped with default setting parameters. Users can change setting according to their own needs. Turn the camera switch to the ON position, install the SD card and SIM card correctly, close the camera with the battery box and fasten the buckles(battery box with 6pcs fully charged 18650 lithium batteries correctly installed), then connect camera to the external display, the camera boots up and enters the preview test mode, you can start setting parameters.

Press **MENU** key to enter/exit the menu. Press ▲ and ▼ to move the marker to choose menu. Press ◀ and ▶ to change the setting, and always press **OK** to confirm and save the changes, or the new setting would not be saved.

Parameter	Settings	Description
Mode	Video +Snap Camera, Video,	Select to take photo or video clips. Video + Snapshot: when the camera enters ON mode to record video, it automatically captures a photo, the size of the photo is same as the video resolution.
Format	Enter	All files will be deleted after formatting the SD card. Highly recommended to format the SD card on the camera at the first using. Caution: make sure the important files on the SD card are backed up before formatting.
Photo Size	4MP, 8MP, 12MP, 16MP, 20MP	Select desired resolution for photo from 4 to 20 megapixels. Higher resolution produces higher quality photo, but occupies more space and slightly affects the shooting interval.
Video Size	4K, 2K	Larger recording sizes have better results, but will take up more SD card space.

Set Clock	Setup	Press the OK button to enter the submenu of clock setting, the date,time and time zone can be set according to the prompts.
Picture No.	01 P, 02 P, 03 P	Select the number of burst shooting at per trigger.
Video Length	Default setting is 10s , optional setting is ' Automatic ' or 2s~60s	Set length of video as required, camera will start recording video as preset length after it is automatically triggered in ON mode and stop recording till preset length is reached. Set as ' Automatic ', the length of video triggered in ON mode will automatically change from range of 5s to 32s. If animal keeps wandering in the detection range when recording video in ON mode, the recording will last up to maximum length of 30s, if animal stop moving or leave detection range, the recording will stop.
Interval	1 Min , optional from 1 second to 60 minutes	Select the length of time that the camera will wait from when the last picture was taken and written on the SD card, to when it responds to any new triggers. It prevents the SD card from filling up with too many redundant images of the same object, save power and SD card space.
Sense Level (Sensitivity)	High, Normal , Low, Off	Select the sensitivity of the PIR sensor. When set to off, the camera will stop PIR induction shooting, it is usually used when time lapse (TIME LAPSE) shooting is turned on (induction shooting and time lapse shooting can work at the same time). Higher sense level with longer sensing distance, but easier to be interfered. The Normal/Low setting suits outdoors while the High setting suits indoors or environment with higher temperature.

		Recommendation: Do not set the sensitivity to high when the temperature is below 25°C.
Time Stamp	Off, On	Select ON the camera or video will automatically mark the time stamp and the photo can show the camera ID, coordinates, temperature and moon phase. Notice: the temperature shown is the internal temperature of the camera, the camera will heat at work, it makes the difference between internal and external temperature and the difference will be small if the camera does not work long time in the field.
Timer1	Off, On	Select On and the camera will automatically work within a specified period of the day. For instance, if the starting time is set at 7:00 and the ending time at 9:00, the camera can be triggered from 7:00 a.m. to 9:00 a.m. Outside this period the camera will not be triggered even animal passes by.
Timer2	Off, On	Select On and the camera will automatically work within a specified period of the day. For instance, if the starting time is set at 10:00 and the ending time at 11:00, the camera can be triggered from 10:00 a.m. to 11:00 a.m. Outside this period the camera will not be triggered even animal passes by.

Normal Weekly	Enter	<p>Monday ~ Sunday: Set up the start and stop shooting times for the camera on a specific day of the week (when conflicting with the exception schedule, prioritize the exception schedule).</p> <p>Off: Turn off the weekly specific working time.</p> <p>On: Set up the specified working time period for each day of the week. (For details, please refer to the section of Schedule Settings.)</p>
Exception	Enter	<p>Exception 1 ~ Exception 10: Set up the start and stop shooting times for the camera on a specific day of the specific month (when conflicting with the Normal Weekly schedule, prioritize the exception schedule).</p> <p>Off: Turn off the specified working time on the designated date.</p> <p>On: Set up the specified working time for the designated date. (For details, please refer to the section of Schedule Settings.)</p>
Password Set	Off, On	<p>After selecting ON, set 4 digits as the power-on password. After password is set, others cannot turn on camera to reset the parameters. Please be sure to record the password, otherwise it is easy to forget.</p>
Serial No.	Off, On	<p>Select On to assign an ID for the camera with 4 digits and/ or alphabets, 0~9 and A~Z, the ID will be imprinted on photo with time stamp On.</p>
Time Lapse	Off, On	<p>Select On, you can set the time period of automatic cycle shooting, and the camera will automatically take pictures/videos without triggering according to the time period set. This feature is useful for shooting cold-blooded animals or observing the</p>

		growth of plants. This function can be used with timer settings.
Beep Sound	On, off	To turn on or off the beep sound caused by pressing the keys. The default setting is On.
SD Cycle	Off, On	Choose On to overwrite the SD card, which automatically deletes the oldest files when the SD card becomes full to make room for the latest pictures or videos.
Audio	Off, On	Turn on or turn off the audio record function when recording video, default setting is On, if you don't want to record sound when recording video, please choose Off.
Default Set	Enter	Press OK button to confirm restoring the camera's menu settings to factory settings(wireless network settings menu is excluded).

Notice: The password setting is available on camera only, but not on PC setup.

3.2 Playback Mode (Manual Send)

Camera connects the external display in ON mode to enter TEST mode, press OK button to enter playback mode, in playback mode you can view the video and photo in camera, press the 'up button' and 'down button' to switch files, press the 'right button' to pause/play, press 'menu button' to open the playback menu, you can choose to delete photo and video, or directly upload the current photo or video to E-mail, FTP, SFTP or Camera Cloud System.

Playback Mode Menu

Parameters	Settings	Description
------------	----------	-------------

Delete	Delete current, Delete all	Delete current: Delete the current viewed photo or video. Delete all: Delete all photos and videos in SD card
Upload	Email, FTP, Cloud System, SFTP	Email: You can upload the previewed photo or video directly to your email. FTP: You can upload the previewed photo or video directly to FTP. Cloud System: You can upload the previewed photo or video directly to the cloud system. SFTP: You can upload the previewed photo or video directly to SFTP.





Note: When using the upload function in playback mode, please make sure that the sending status in the wireless settings menu is not 'Off', and the upload parameters such as Email, FTP, SFTP, and Camera Cloud System are set correctly.

Unplug the SD card from camera and insert into SD card reader, connect the SD card with computer through the card reader, you can browse photos and videos directly on computer, files taken by Lti-8830 camera are stored in the folder DCIM in SD card, the photo format is JPG, video format is MP4 of H.265.

Set the send image size as thumbnail, the thumbnail generated by photo and video will be saved in folder DCIM/100IMAGE.

The MP4 video file can be played on most popular media players. If it cannot be played by the player you used, please try another.

3.3 Set up Wireless Network Menu on Camera

The camera connects with external display to enter TEST mode, press  to enter the wireless network setting menu. Press button , , ,  to select, and press button **OK** to confirm.

Parameter	Settings	Description
Language	English	Select the system language.

<p>Network Mode</p>	<p>Auto,4G,5G</p>	<p>Select 'Auto': automatically search and connect to 4G or 5G network signal when the wireless module is turned on. Select '4G': when the wireless module is turned on, only 4G network can be connected. Select '5G': when the wireless module is turned on, only 5G network can be connected.</p>
<p>Send Status</p>	<p>Off, Email, FTP, Ltl Camera Cloud System, SFTP</p>	<p>Off: Turn off the 4G communication function, then the camera would work as a basic scouting camera and 4G function would not be activated and consume power Email: Set the recipient email address and sender email address of camera for email. FTP: Set FTP parameters and save directory. Ltl Camera Cloud System: Set upload parameters of Ltl Camera Cloud System . SFTP: View SFTP parameters, saving directory and SFTP key MD5.</p>
<p>Operator</p>	<p>Auto Setting, Operator Manual Setting</p>	<p>Auto Setting: The camera with pre-load setting of main operators from the worldwide, choose the operator name to finish the setting easily. Operator Manual Setting : Enter the data of SIM card operator manually.</p>

<p>Remote Control</p>	<p>Off, 10 minutes , 1 Hour ~24 Hour</p>	<p>Default Off: cannot change camera setting by sending SMS command. 10 minutes, 1 to 24 hours: interval time to wake up camera to receive SMS commands. For example, if you set the SMS remote control time as 1 hour, the 4G module in the camera will wake up and start receiving SMS every one hour. i.e. the control command is possible to be responded more than 1 hour. SMS control can be used to change camera parameters and control the camera to take picture and send it back. As the setting time, the camera will start to search if any control message is received , therefore, the shorter the time is set, the more timely it will respond to the control command, but the more power it consumes too. In this menu, remote control phone number and remote receiver email can be set.(Note: the camera will not record image for time lapse or auto trigger when the wireless module is working)</p>
<p>Query IMEI Number</p>	<p>OK</p>	<p>Press OK to confirm and show the IMEI number of the module.</p>
<p>Software Version</p>	<p>OK</p>	<p>Show the software version of the camera.</p>
<p>Send Image Size</p>	<p>Full Image, Thumbnail</p>	<p>Full image: camera would automatically send original picture or video to the preset E-mail, FTP, SFTP or Ltl Camera Cloud System after shooting. Thumbnail: camera would send thumbnail to E-mail, FTP, SFTP or Ltl Camera Cloud System after shooting (Video cannot be sent in Thumbnail mode).</p>

<p>Coordinate</p>	<p>Startup Settings, Coordinate Input, Coordinate mailbox, Format Select</p>	<p>Startup Settings: off, 00:00 every day, Every induction; when ' off ' is selected, the GPS function will no longer be activated. 00:00 every day: activate GPS at 00:00 every day in ON mode, correct the coordinates and camera clock. Every induction: activate GPS every time the camera captures image in ON mode, as well as correct the coordinates and camera clock. Coordinate Input: input the location coordinates manually; Coordinate mailbox: GPS coordinates mailbox: Set up the email to send and receive notification of coordinates change, when the camera is moved, the GPS will be activated at next trigger and the latest coordinates will be updated to camera and sent to the email appointed(the Send Status setting must not be set to off, otherwise it won't work). Format Select: Set up latitude and longitude in degrees, minutes and seconds or decimal format.</p>
<p>Environment Monitor (Heartbeat)</p>	<p>On,Off</p>	<p>On: Turn on heartbeat function, meanwhile, camera automatically collects environmental data (temperature, humidity and illumination, etc.) every 5 minutes in ON mode when the environmental detector is connected and uploads the collected data every 6 hours (4G Send Option should be set to Camera Cloud System). Off: Turn off the environmental data collection function and the heartbeat function.</p>

Default Set	OK	Press OK key to confirm, the 4G parameters would return to default setting (it would not return the camera parameters to default setting).
--------------------	-----------	--

Note: When the send status is set to Email, FTP, SFTP or Ltl Camera Cloud System, camera cannot shoot when the wireless network module is working in ON mode, at this time if value of the "interval" or "time lapse" is set very small, such as only a few seconds, then the actual shooting interval will be longer than the setting, it is normal. Usually it takes at least tens of seconds to send a video (depending on the size of the file being sent and the network environment).

3.4 Set up Camera on PC

Visit the website of LTL ACORN directly and download the software CameraSetup.exe.

According to the link <http://www.ltlacorn.cn> (Download —> PC SETUP Download —> CameraSetup.exe), download and save it on the computer, run the CameraSetup.exe software.

Then format the SD card on the camera, eject the SD card and insert it into the computer. If your computer cannot read SD card, you may need to purchase an SD card reader separately.

Below is the icon of the CameraSetup.exe software:

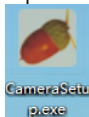

Double click the CameraSetup.exe icon, you will see below page :

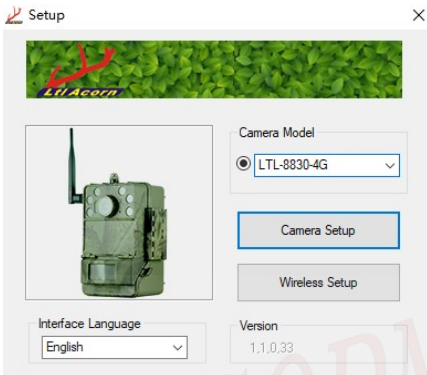

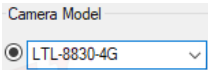
Click  to choose the camera model: LTL-8830-5G or LTL-8830-4G.

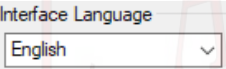
Click  to choose the software language of the interface.

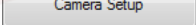
Click  to enter camera setting interface:

Mode	Video+Snapshot	Photo Size	8 MP	
Video Size	4K	Picture Number	01 Photo	
Time Stamp	On	Sense Level	medium	
Side PIR	Off	Video Length	10 Sec	
Interval	1 Min	Date Format	YYMMDD	
Beep Sound	On	SD Cycle	Off	
Language	English	TV System		
Time Zone	UTC+08	Video Sound	On	
Set Clock	Auto	2022 / 03 / 07 17 : 43 : 51		
Timer1	Off	Start Hour : Min	End Hour : Min	
Timer2	Off	Start Hour : Min	End Hour : Min	
Serial Number	Off	0 0 0 0		
Time Lapse	Off	Hour : Min : Sec	0 : 0 : 0	
Coordinate	Direction	Degree	Minute	Second
Longitude	E	0	0	0
Latitude	N	0	0	0
Save Path	Browse	C:\Users\MAIBENBEN\Desktop		
Default		Generate		

Set the camera as your requirements. Please refer to section **3.1 Set up**

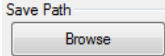
Parameters on Camera for better operation. Click  to choose the save directory, SD card root directory is recommended (connect SD card to computer with SD card reader first).

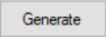
Click  and the below window will pop out:

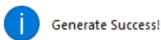



Then click  to exit. A file named **menu.dat** has been created and saved in the selected directory, before inserting the SD card into camera, please copy the **menu.dat** file to the root directory of the SD card if you didn't choose SD card to save the file before.



Click  to restore to default settings, generate **menu.dat** file.

Click  to exit the setting interface. Copy the **menu.dat** file to the **root directory of the SD card**, retrieve the SD card and insert into camera. After correctly connecting the camera with external display to enter TEST mode, "**Update Config Success**" appears on display indicates the camera parameters have been updated successfully.

3.5 SMS Remote Control & Table of Command Code

In order to communicate well with your camera via text message/SMS, format your texts and send in a certain way is needed. Or please download the mobile APP to send command, it would be easier.

- All the SMS commands should start with "LTL(ltl)" and end with "AA(aa)".
- Between "ltl" and "aa", insert the specific commands you want the camera to perform. You can choose one command at a time, but it saves time to combine commands to send together.
- A specific command is made up with four parts in the following sequence: a two-digit command code, an asterisk (*), a code value (a number or a combination of number and letter), and lastly a pound/hash sign (#).
- Both capitalized and non-capitalized letters can be used in a same command.
- Do NOT leave any spaces between any of the letters and symbols.

- Do NOT put a comma or period in the command. Do NOT include any quotation marks in a command; they are used here just for explanation purposes.
- The maximum for text messages is 60 bytes. If you want to send multiple commands, please do so in separate texts to avoid failure sending.

An example of a command: LTL01*1#06*S30#07*10A3Z#62*1#AA

It means to ask the camera to 1. set camera to video mode, 2.set interval between PIR induction to 30 seconds, 3. set serial number to "0A3Z", 4. according to the current mode and send status, immediately shoot and send to you.

- For SMS remote control interval, different value with different power consumption: "0" the highest and "off" zero.
- Camera will reply you message as below format when your SMS command is in correct format and received:
Message "LTL..." format OK.
SQ4,R1,G1,B3.

Attention: The content in the replied message in quote marks ("...") is the front part of the SMS command due to message length limitation.

SQ4 means signal strength is 4,MAX: 4 (0~4).

R1 indicates the network registration and status: 0: didn't register the network and the module didn't find the operator; 1: registered to the local network; 2: found the operator but didn't register the network; 3: the registration was rejected; 4: unknown data; 5: the registration is in roaming status;

G1 indicates the status of data network registration, 1 and 5 means the data network can be used, otherwise means the exception of data network registration, it cannot be used.

B3~B0 represents for battery level, B3 for high level, B1 for low level, please replace battery as soon as possible when B1.

Table of Command Code

Command Code	Function of Command Code	Example	Meaning
01	Camera (0), Video (1), Video + Snapshot (2)	01*1#	set to video mode

02	Image Size: 4MP(0), 8MP(1), 12MP(2) , 16MP(3) , 20MP(4)	02*1#	8MP
03	Video Size: 4K (0), 2K (1),	03*1#	2K
04	Picture Number: 01 Photo (0), 02 Photos (1), 03 Photos (2)	04*2#	3 photos
05	Video Length: 1-60 indicates value of second	05*59#	59 seconds
06	Interval: beginning with S(s) represents second, with M(m) represents minute, 1-60 indicates different value	06*s30#	Interval: 30 seconds
07	Serial Number: Off (0), turn off serial number 07*0xxx#; On (1), refer to camera setting, digit+ letter.	07*1ABCD#	Serial Number: ABCD
08	Sense Level: Low (0), Normal (1), High (2), Off (3)	08*1#	Normal
09	Time Stamp: Off (0), On (1)	09*0#	Off
10	Side PIR: Off (0), On (1)	10*1#	On
14	Recipient Email 1: Maximum 48 types	14*info1@ltlacorn.cn#	Email Address: info1@ltlacorn.cn
15	Recipient Email 2: Maximum 48 types	15*info2@ltlacorn.cn#	Email Address: info2@ltlacorn.cn

16	Remote Receiver Email (receive full size picture of command code 22): Maximum 48 types	16*info@ltlacorn.cn#	Email Address: info@ltlacorn.cn
18	Time Lapse: Off (0), On (1). Time indicated with 2 digits, e.g.: 1 Hour 30 Min 0 Sec, indication: 013300.	18*1013000#	The camera takes photo/video every one and a half hour no matter triggered or not.
19	Timer1: Off (0), On (1). Time indicated with 2 digits, e.g.: 13 Hour 30 Min, indication: 1330.	19*113301530#	Camera works at 1:30pm ~3:30pm
20	Timer1: Off (0), On (1). Time indicated with 2 digits, e.g.: 13 Hour 30 Min, indication: 1330.	20*113301530#	Camera works at 1:30pm ~3:30pm
21	Remote Interval: 0-24, 0 indicates interval of 10 minutes, 25 indicates Off. 1-24 indicates interval time to receive SMS command.	21*25#	Off (need to turn on manually after turning off)
22	Request Full Image: Camera will send original picture to recipient E-mail address after receiving the command; (note: folder and file name must be capital letter).	22*100IMAGE \IMAG202106 1801020400.JPG#	Request full size picture (example of command 22: 22*100IMAGE/IMAG2021061801020400.JPG#, will upload the original photo. If IMAG001 is video, send sms command 22*IMAG2021061801020400.MP4# to upload the

			video.
23	Size of sending picture: 0 for full size picture; 1 for thumbnail;	23*0#	Send full size picture
60	Get the camera to take picture immediately and send to your remote control mobile, On (1). This code is workable in these mode: Camera, Video, Video + Snap.	60*1#	The camera would take a picture immediately and send to E-mail after receiving this SMS command.
61	This command controls the camera to take a video immediately (no matter the current mode is 'Camera', 'Video' or Video + Snap.' mode) and send the video to the remote receiver E-mail.	61*1#	The camera would take a video immediately and send to E-mail after receiving this SMS command.
62	This command controls the camera to start shooting immediately, according to the mode set to take Camera', 'Video' or Video + Snap, and then send, it according to the set sending options (E-mail, FTP, SFTP or Ltl Camera Cloud System).	62*1#	Camera starts shooting (according to the mode preset) after receiving this SMS command, then uploads according to the send status preset.

3. 6 View Local MPNO Name and Signal Strength on TFT Screen

Camera connects with external display and power on, enters TEST preview mode. Wait about 1 minute till you hear a short beep, then you will be able to

see the MPNO symbol and the signal strength on the LCD.

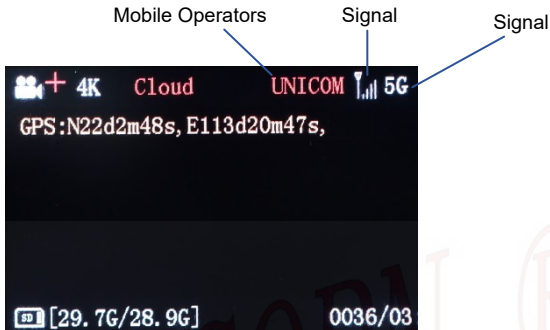

In order to ensure the 4G module works properly, the signal strength should be at least 2 bars. If there is only one bar of signal, it may cause the sending and receiving of the camera is not very well.

If a code other than the MPNO symbol shows up on the screen, it indicates something is wrong. Specifically as:

- **WAIT...:** Searching signal or no signal received.
- **NO MDM:** The module is not found or detected.
- **SIM ERR:** Please check if SIM card is inserted correctly.
- **REG ERR:** Not registered, it is not currently in the state of searching and registering a new operator, please check whether the camera is locked to a specific frequency band and there is no signal nearby, whether a private network is used and APN information needs to be set.
- **REG RFU:** Registration rejected
- **REG UNK:** Unknown status, please check whether the SIM card is password protected, whether the camera is locked to a specific frequency band and there is no signal of the band nearby, the account is in arrears or the network signal is too poor.
- **DIAL ERR:** The registration service has been completed, and the dial-up may be unsuccessful due to poor network signal. Please check if the antenna is damaged or if it is using the antenna provided by manufacturer.

Set up Schedule on Computer

The schedule function includes weekly plan **Normal Weekly** and special schedule **Override Exception**. The Normal Weekly allows the camera to work in a specified time period each week, and the **Override Exception** allows the camera to work in a specified time period on a specified date.

The Schedule can only be set by using the Schedule Settings software on the computer, please download it by scanning the QR code.



Schedule SettingsV1.0.exe
POSIX WinThreads for Windows
MingW-W64 Project. All rights...

Enter the downloaded software Schedule Settings.exe on computer and set up Normal Weekly and Override Exception.

Check the box means activate the schedule, click to set up the date and time as required,

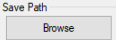
then click  to select the save path for saving the setting file, and click

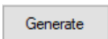

, it will pop out a window

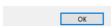

Click to exit the setting interface.

Copy the schedule.dat file to the root directory of the SD card, retrieve the SD card and insert into camera. After correctly connecting the camera with external display to enter TEST mode, "Update Config Success" appears on display indicates the camera parameters have been updated successfully.

Schedule Menu Description:

Normal Weekly: the work schedule can be set for 1 week of 7 days. Weekly schedule is used to perform daily arming and disarming acts.

Arm Time: turn on IR detection(works after IR detection/time lapse is set).

Disarm: disable IR detection(time lapse and IR detection both won't work).

Normal Weekly	Disarm	Arm Time
Monday	9:00	17:00
Tuesday	9:00	17:00
Wednesday	9:00	17:00
Thursday	9:00	17:00
Friday	9:00	17:00
Saturday	00:00	00:00
Sunday	00:00	00:00

Example of normal weekly schedule:

With above settings, from Monday to Friday, camera starts working at 17:00 (works after IR detection/time lapse is set) and stops working at 9:00 (won't work even the IR detection/time lapse has been set);

Camera works the whole day on Saturday and Sunday.

Override Exception : 10 dates could be set.E.g.: holiday, the date set won't execute the normal weekly schedule.

Override Exception	Date Setting	Disarm	Arm Time
Date1	27/09/ (27th Sep.)	15:30	17:00
Date2	01/01/ (1st Jan.)	0:00	0:00
Date3			
Date4			
Date5			
Date6			
Date7			
Date8			
Date9			
Date10			

Example of override exception schedule:

With above settings, no matter the day of the week on 27 Sep., camera executes the disarm time 15:30 and arm time 17:00 of Override Exception.

With above settings, no matter the day of the week on 1st Jan., camera executes the disarm time 00:00 and arm time 00:00 of Override Exception, camera works(arm) the whole day.

E-mail Uploading Function







Ltl-8830-4G or 5G series cameras have a function of email uploading, which

can send the files record by camera to the email set by the user. Camera connects with external display and power on, enters TEST preview mode, correctly set the send Email parameters and receiver email address, then unplug the external display, enters ON mode, the camera can automatically shoot and send to Email according to the settings.

The size of the video file will be different in different scene. Please take the actual scene record as the standard.

Note: When the email attachment exceeds the limit size of email, it cannot be sent successfully. Therefore, please confirm the maximum limit of the attachment allowed by your email when selecting the email address, and make sure that the file size captured by the camera is in the range allowed by the email address.

4.1 Setup E-mail Parameters on Camera

Camera connects with external display and power on to enter TEST mode, press  to enter wireless network setting menu. Press  and  key to choose the menu "Send Status", press  to enter "Send Status", then press  and  key to choose "Email", the Email parameters can be set.

The E-mail menu is as below:

Parameters	Setting	Description
Set Parameters	Server, Port, E-mail, Password	Set E-mail of sending email
Set E-mail Address 1	/	Set receiver E-mail address to receive photo or video sent by camera.
Set E-mail Address 2	/	Set receiver E-mail address to receive photo or video sent by camera.

4.2 Set up E-mail Parameters on PC

Below is the icon of the CameraSetup.exe software:

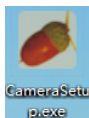

Double click the CameraSetup.exe icon, you will see below page :

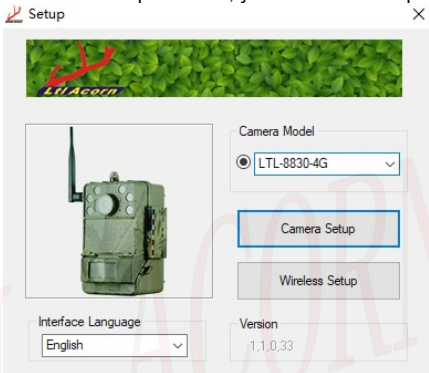

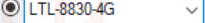
Click  to choose the camera model: LTL-8830-5G or LTL-8830-4G.

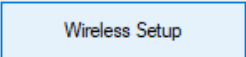
Click  to enter camera setting interface:

Send Status: Email

Operator Parameter Options: Select Operator

Operator Selection

Country: China

Operator: China Unicom

MMS Parameters

URL

APN

Gateway

Port

Account

Password

FTP Settings

Server

Port: 21

User Name

Password

Upload to FTP directory (must exist): Root

Network Settings, Mail Parameters

Network Settings

APN

Account

Password

Sender Settings

GPS coordinates mailbox

Server

Port

Email Address

Account

Password

Next Page

Select “Send Status” as “Email” in “wireless Parameter Settings” window:

Send Status

Email

Off

Email

FTP

Camera Cloud System

Set the network parameters of the SIM card operator (select the operator network parameters, or manually enter the URL, gateway, APN, port settings, etc. according to the prompt).

Operator Parameter Options

Select Operator

Select Operator

Manual Input

Select the operator parameters as required.

Operator Selection

Country:

Operator:

Sender Settings

GPS coordinates mailbox

Server:

Port:

Email Address:

Account:

Password:

Set sender email parameters:

Wireless Parameter Settings

Send Status: Operator Parameter Options:

Operator Selection

Country: Operator:

MMS Parameters: URL: FTP Settings: Server:

GPS coordinates mailbox

Sender Settings

Server:

Port:

Email Address:

Account:

Password:

Inbox:

Inbox address:

OK

Account:

Password:

Sender Settings GPS coordinates mailbox

Server:

Port:

Email Address:

Account:

Password:

Next Page

Click **GPS coordinates mailbox** **Sender Settings** **GPS coordinates mailbox** can set up the email to send and receive GPS coordinates, when the camera location is changed, the alarm will be sent by the preset email, the latest GPS coordinates and image will be sent to the inbox email address, if you don't need this function, please leave it unchecked.

Click **Next Page** to set the receiver E-mail, sending option, mobile number and E-mail for camera remote control, remote control interval, etc.

Send Settings ×

To Destination

Phone Number 1 Phone Number 2

Email Address 1 Email Address 2

Send Image Size **Full Image** ▾

Max Sent Num /Day

Send Mode

Send Mode **Send Immediately** ▾

Daily Send Time

Remote Control

Remote Interval **Remote Off** ▾ Do not use remote command - 22

Remote Phone Number Remote Receiver Email

^ Remote control, receiving 60 command photos. ^ Receives the file requested by the 22 command.

Save Path

Browse

Previous Page **Generate**

Save Path

Browse

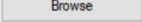
Click  to choose the save directory, SD card root directory is recommended (connect SD card to computer with SD card reader first).

Generate

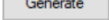
After finishing setting, click , the below prompt window would be shown when generate the file successfully:

Notice



Generate Success!

OK





Click  to exit the setting interface. Copy the **CFG.BIN** file to the root directory of the SD card, retrieve the SD card and insert into camera. After correctly connecting the camera with external display to enter TEST mode, "**Update Config Success**" appears on display indicates the camera parameters have been updated successfully.

Note: If the remote control function is enabled, the remote mobile phone number must be filled, it is used to send SMS command, and the camera only executes the remote control commands from this number.

FTP Uploading Function

LTL-8830-5G or LTL-8830-4G cameras have a function of FTP uploading, which can upload the files record by camera to the appointed FTP server. Camera connects with external display and power on to enter TEST mode, correctly set the FTP upload parameters, then unplug the external display to enter ON mode, camera will auto record and send to FTP server as setting.

5.1 Setup FTP Parameters on Camera

After correctly inserting the external button control box with display screen, battery and SD card, set the camera switch to the ON position, and enter the preview test mode after the camera is turned on, Press  to enter the wireless settings menu. Press ,  key to select the "Send Status" menu, press **OK** key to confirm entry, and then press ,  key to select "FTP", press **OK** key to confirm entry then you can set FTP parameters.

The FTP menu is as below:

Parameters	Setting	Description
Set Parameters	Server, Port Account, Password	Set parameters of FTP site.
Upload to FTP Catalogue	Root Catalogue, Appointed Catalogue	Root Catalogue: upload the files to root catalogue of FTP site directly. Appointed Catalogue: upload the files to appointed catalogue of FTP site directly and input name of appointed catalogue.

Note: The specified directory should have existed.

5.2 Set up FTP Parameters on PC

Below is the icon of the CameraSetup.exe software:

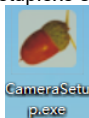

Double click the CameraSetup.exe icon, you will see below page :

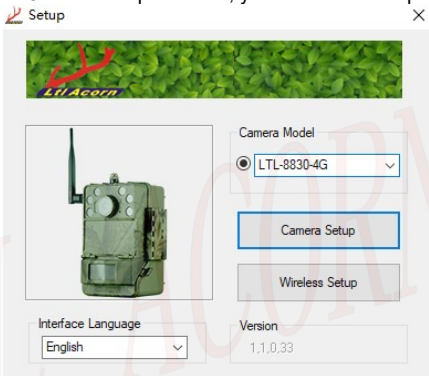

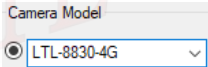
Click  to choose the camera model: LTL-8830-5G or LTL-8830-4G.

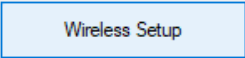
Click  to enter camera setting interface:

Wireless Parameter Settings

Send Status: FTP

Operator Parameter Options: Select Operator

Operator Selection

Country: China

Operator: China Unicom

MMS Parameters

URL: _____

APN: _____

Gateway: _____

Port: _____

Account: _____

Password: _____

FTP Settings

Server: _____

Port: 21

User Name: _____

Password: _____

Upload to FTP directory (must exist)

Root: /

Network Settings, Mail Parameters

Network Settings

APN: _____

Account: _____

Password: _____

Sender Settings GPS coordinates mailbox

Server: _____

Port: _____

Email Address: _____

Account: adla@qq.com

Password: _____

Next Page

Select "Send Status" as "FTP" in "wireless Parameter Settings" window:

Send Status

FTP

Off

Email

FTP

Camera Cloud System

Set the network parameters of the SIM card operator (select the operator network parameters, or manually enter the URL, gateway, APN, port settings,

Operator Parameter Options

Select Operator

Select Operator

Manual Input

etc. according to the prompt)

Select the operator parameters as required.

Operator Selection

Country	Operator
China	China Unicom

Set up “Server”, “Port”, “User name” and “Password” in “FTP Settings” and the FTP directory for uploading.

FTP Settings

Server

Port

21

User Name

Password

Upload to FTP directory (must exist)

Root /

MMS Parameters

URL

APN

FTP Settings

Server

Port

21

GPS coordinates mailbox

Sender Settings

Server

Port

Email Address

Account

Password

Inbox

Inbox address

OK

Sender Settings GPS coordinates mailbox

Click **GPS coordinates mailbox**

Sender Settings GPS coordinates mailbox

can set up the email to send and receive GPS coordinates, when the camera location is changed, the alarm will be sent by the preset email, the latest GPS coordinates and image will be sent to the inbox email address, if

you don't need this function, please leave it unchecked.

Click [Next Page](#) to setup "Sending Image Size", "Save Path" and remote control parameters in the window of "Send Settings".

 **Send Settings** ×

To Destination

Phone Number 1	Phone Number 2
<input type="text"/>	<input type="text"/>
Email Address1	Email Address2
<input type="text"/>	<input type="text"/>

Send Image Size Full Image ▾

Max Sent Num /Day

Send Mode

Send Mode Send Immediately ▾

Daily Send Time

Remote Control

Remote Interval Remote Off ▾ Do not use remote command - 22

Remote Phone Number Remote Receiver Email

^ Remote control, receiving 60 command photos. ^ Receives the file requested by the 22 command.

Save Path

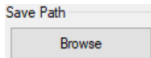

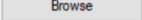
Click  to choose the save directory, SD card root directory is recommended (connect SD card to computer with SD card reader first).

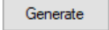
After finishing setting, click , the below prompt window would be shown when generate the file successfully:

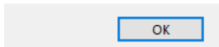
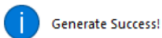

Please click the close button  in top right corner of the window to close the window.

Copy the **CFG.BIN** file to the root directory of the SD card, retrieve the SD card and insert into camera. After correctly connecting the camera with external display to enter TEST mode, "**Update Config Success**" appears on display indicates the camera parameters have been updated successfully.

SFTP Uploading Function

LTL-8830-5G or LTL-8830-4G cameras have a function of SFTP uploading, which can upload the files record by camera to the appointed SFTP server.

5.1 Setup SFTP Parameters on Camera

Due to the numerous parameters involved in SFTP, SFTP parameters cannot be set on camera menu, the camera menu is only used for selecting SFTP as upload method and viewing SFTP parameters.

The SFTP menu is as below:

Parameters	Setting	Description
Set Parameters	Server, Port Account, Password	View settings about SFTP site.
Upload to SFTP Catalogue	Root Catalogue, Appointed Catalogue	Set up the SFTP folder path for uploading. Root Catalogue: upload the files to root catalogue of SFTP site directly. Appointed Catalogue: upload the files to appointed catalogue of SFTP site directly and input name of appointed catalogue.
SFTP Key MD5	/	View SFTP key MD5

Note: The specified directory should have existed.

5.2 Set up SFTP Parameters on PC

Scan the QR code on the packing box with your smartphone, visit the website to download and save the software LTL-8830_SFTP_CFG.exe to your computer.



Double click the software LTL-8830_SFTP_CFG.exe,you will see below page:

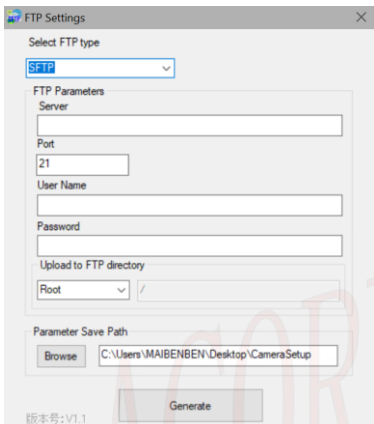



In this page, set **Server**, **Port**, **User Name**, **Password**, and **Upload to FTP directory** (set the SFTP folder path for uploading).

Note: If SFTP requires logged in with key, the password field can be entered any content arbitrarily.

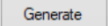
Click  to choose the save directory, SD card root directory is recommended (connect SD card to computer with SD card reader first).

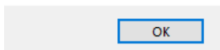
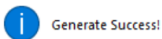
After finishing setting, click , the below prompt window would be shown when generate the file successfully:



Please click the close button  in top right corner of the window to close the window.

Copy the **CFG.BIN** file to the root directory of the SD card, retrieve the SD card and insert into camera. After correctly connecting the camera with external display to enter TEST mode, "**Update Config Success**" appears on display indicates the camera parameters have been updated successfully.

After the SFTP configuration is completed, press the left button to enter the wireless network setup menu, select Send Status as SFTP, enter the SFTP settings to check whether the configuration is correct.

Login with SFTP Key





For SFTP server requires key to log in, please rename the private key as **key**, copy it to the root directory of the SD card and insert the SD card into camera, then power on the camera, if display shows **Update Config Success** means the key has been updated to camera.

Note: The SFTP key and CFG.BIN configuration file can be copied to the root directory of the SD card and updated to camera at the same time.

Ltl Camera Cloud System Settings

LTL-8830-5G or LTL-8830-4G cameras have a function of Ltl Camera Cloud System uploading, which can upload the files record by camera to Ltl Camera Cloud System server. Camera connects with external display and power on, enters TEST preview mode, correctly set the Ltl Camera Cloud System parameters, then unplug the external display, enters ON mode, the camera can automatically shoot and upload to cloud system according to the settings.

6.1 Set Parameters of Ltl Camera Cloud System on Camera

After correctly connecting the external display, battery and SD card, set the camera switch to the ON position, and enter the preview test mode after the camera is turned on. Press Key to enter the 'wireless settings' menu, press ,  key to select the "Send Status" menu, press **OK** key to confirm entry, press ,  key to select "Ltl Camera Cloud System" menu, press **OK** key to confirm entry then you can set the parameters of Ltl Camera Cloud System.

The related menu items of the Ltl Camera Cloud System are as below:

Parameter	Settings	Descriptions
Set parameters	Registered E-mail, login password, SIM card phone number	Registered email: user's login account of Ltl Camera Cloud System; Login password: the password that the user enters when logging into the Ltl Camera Cloud System; SIM card phone number: the phone number entered when adding the camera to the Ltl Camera Cloud System (better to be same as the SIM card number installed in the camera).

6.2 Set Parameters of Ltl Camera Cloud System on Computer

Below is the icon of the CameraSetup.exe software:

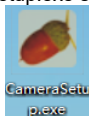

Double click the CameraSetup.exe icon, you will see below page :

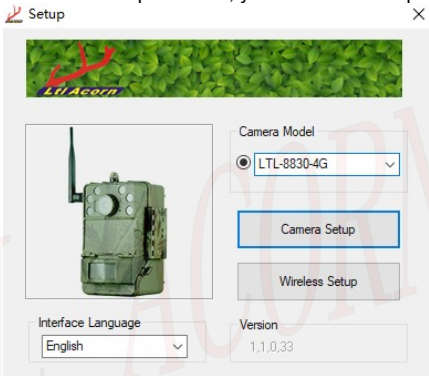

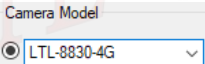
Click  to choose the camera model: LTL-8830-5G or LTL-8830-4G.

Click  to enter camera setting interface:

Wireless Parameter Settings

Send Status: Camera Cloud System (dropdown) | Operator Parameter Options: Select Operator (dropdown)

Operator Selection: Country: China (dropdown) | Operator: China Unicom (dropdown)

MMS Parameters:

URL: [text field]

APN: [dropdown]

Gateway: [text field]

Port: [text field]

Account: [text field]

Password: [text field]

Camera Cloud System Parameters:

Registered mail: [text field]

Login Password: [text field]

SIM card phone number: [text field]

Network Settings, Mail Parameters:

Network Settings:

APN: [text field]

Account: [text field]

Password: [text field]

Sender Settings:

 GPS coordinates mailbox

Server: [text field]

Port: [text field]

Email Address: [text field]

Account: adla@qq.com

Password: [text field]

Next Page

In the Wireless Parameter Settings window, select “Send Status” as

Send Status dropdown menu:

- Camera Cloud System (selected)
- Off
- Email
- FTP
- Camera Cloud System

“Camera Cloud System”:

Set the network parameters of the SIM card operator (select the operator network parameters, or manually enter the URL, gateway, APN, port settings,

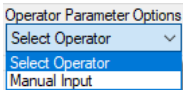

etc. according to the prompt)

Select the operator parameters as required.

A form titled "Operator Selection" with two dropdown menus. The "Country" dropdown is set to "China" and the "Operator" dropdown is set to "China Unicom".

Set "Registered mail", "Login Password" and "SIM card phone number" in the "Ltl Camera Cloud System Parameters" group box.

A form titled "LTL Camera Cloud System Parameters" with three input fields: "Registered mail", "Login Password", and "SIM card phone number".A composite image showing two forms: "MMS Parameters" (with URL and APN fields) and "Camera Cloud System Parameters" (with Registered mail and Login Password fields). Overlaid on these is a dialog box titled "GPS coordinates mailbox" with a close button (X). The dialog box contains "Sender Settings" with fields for Server, Port, Email Address, Account, and Password, and an "Inbox" section with an "Inbox address" field. An "OK" button is at the bottom. Below the dialog box, a checkbox labeled "Sender Settings" is checked, and the text "GPS coordinates mailbox" is visible.

Click **GPS coordinates mailbox**

Sender Settings GPS coordinates mailbox

can set up the email to send and receive GPS coordinates, when the camera location is changed, the alarm will be sent by the preset email, the latest GPS coordinates and image will be sent to the inbox email address, if

you don't need this function, please leave it unchecked.

Click [Next Page](#) to setup "Sending Image Size", "Save Path" and remote control parameters in the window of "Send Settings".

 **Send Settings** ✕

To Destination

Phone Number 1	Phone Number 2
<input type="text"/>	<input type="text"/>

Email Address1	Email Address2
<input type="text"/>	<input type="text"/>

Send Image Size

Max Sent Num /Day

Send Mode

Send Mode

Daily Send Time

Remote Control

Remote Interval <input type="text" value="Remote Off"/>	<input type="checkbox"/> Do not use remote command - 22
Remote Phone Number <input type="text"/>	Remote Receiver Email <input type="text"/>

^ Remote control, receiving 60 command photos.

^ Receives the file requested by the 22 command.

Save Path

Save Path

Browse

Click **Browse** to choose the save directory, SD card root directory is recommended (connect SD card to computer with SD card reader first).

Generate

Click **Generate** after setting, a prompt window will appear when the configuration file is successfully generated:

Notice



Generate Success!

OK

OK

To close the window, please click the close button **OK** at the upper right corner of the window.

Copy the **CFG.BIN** file to the root directory of the SD card, retrieve the SD card and insert into camera. After correctly connecting the camera with external display to enter TEST mode, "**Update Config Success**" appears on display indicates the camera parameters have been updated successfully.

6.3 Ltl Camera Cloud System Remotely Modifies Camera Parameters

Set the 4G send options as Ltl Camera Cloud System, log in Cloud System on computer or mobile APP, you can remotely modify camera parameters though the camera parameters setting function on the Ltl Camera Cloud System.

Take computer web page operation as an example: click on the **Account**



Account Settings

Settings button on the web page in the Ltl Camera Cloud

System, then click the **camera settings** button **Camera settings** of setting menu on the left side of the page and enter the page of camera parameter setting. In this page you can modify the camera setting.

Camera select:

2-15688888888

Click the **camera settings** on the camera

parameter settings interface, select the camera model you need to set and select the camera parameters to modify on the web page, after the settings is completed, click to generate configuration files. When the camera uploads photos to the Ltl Camera Cloud System, the configuration file in the Ltl Camera Cloud System will be downloaded and updated to the camera. The camera will respond to the newly modified command parameters in the next trigger.

Camera select:	<input type="text" value="B-1562222222"/>			
Camera mode:	<input type="text" value="Photo+video"/>	Photo Size:	<input type="text" value="10MP"/>	
Video Size:	<input type="text" value="720P"/>	Shot number:	<input type="text" value="01photos"/>	
Time stamp:	<input type="text" value="ON"/>	Sensitivity:	<input type="text" value="normal"/>	
SidePIR:	<input type="text" value="ON"/>	Videotape time:	<input type="text" value="10"/>	Sec
Timeinterval:	<input type="text" value="1"/> Minute	Wireless send:	<input type="text" value="ON"/>	
Send Image Size:	<input type="text" value="Full Image"/>	Remote control time:	<input type="text" value="1Hour"/>	
Remote Receiver mail:	<input type="text" value="2850427074@qq.com"/>			
Phone Number1:	<input type="text"/>	Phone Number2:	<input type="text"/>	
Email Address1:	<input type="text" value="2850427074@qq.com"/>			
Email Address2:	<input type="text"/>			
Coordinate	Direction	Degrees	Min	Sec
Longitude:	<input type="text" value="East"/>	<input type="text" value="113"/>	<input type="text" value="8"/>	<input type="text" value="48"/>
Latitude:	<input type="text" value="North"/>	<input type="text" value="23"/>	<input type="text" value="50"/>	<input type="text" value="1"/>
Timing setting				
Timing setting1:	<input type="text" value="Off"/>	Start :	<input type="text" value="0Hour"/> <input type="text" value="0Min"/>	End : <input type="text" value="0Hour"/> <input type="text" value="0Min"/>
Timing setting2:	<input type="text" value="Off"/>	Start :	<input type="text" value="0Hour"/> <input type="text" value="0Min"/>	End : <input type="text" value="0Hour"/> <input type="text" value="0Min"/>
Sequence number setting				
Serial No.:	<input type="text" value="Off"/>	<input type="text" value="0"/>	<input type="text" value="0"/>	<input type="text" value="0"/>
Timing shooting setting		Hour	Min	Sec
Time shooting:	<input type="text" value="Off"/>	<input type="text" value="0Hour"/>	<input type="text" value="0Min"/>	<input type="text" value="0Sec"/>

Default

Generate

6.4 Ltl Camera Cloud System Introduction

Ltl Camera Cloud System is a comprehensive network camera management system integrating camera image reception, image management, camera management, environmental data analysis and camera remote control. The users log in the camera cloud system on the mobile APP or computer web browser, allowed to view and manage the images and videos uploaded by the camera, remotely manage the camera, modify the camera setting parameters, etc.

Open web browser and enter website: <http://ltl.miniacorn.us/index> to enter the Ltl Camera Cloud System login interface:

The screenshot shows the LtlAcorn Camera Cloud beta login and registration interface. The interface is split into two main sections: a login section on the left and a registration section on the right. The login section has a 'sign in' button and a 'register' button (highlighted with a red dashed box). Below these are input fields for 'Account' and 'Password', a 'login' button, and a 'Mobile LtlAcorn Cloud' button. The registration section has a 'sign in' button and a 'register' button (highlighted with a red dashed box). Below these are input fields for 'Account' (Email), 'Code' (Mail received verification code), 'Password' (0-9a-zA-Z not less than 8), 'Pwd again' (Password confirmation), and 'IMEI' (Camera menu query). There are 'Get Code' and 'Register' buttons.

Click "register" at the right side and follow the prompts to fill out the information to register the account.

Click "register ", enter the account and password, click on the login button to login the Ltl Camera Cloud System.

Click " Mobile LtlAcorn Cloud " to enter the download page of Ltl Camera Cloud System Mobile APP, download and install the mobile phone APP according to the prompts.

After logging into the Ltl Camera Cloud System on computer, click button



Account Setting in the Ltl Camera Cloud System page,

Setting
Image upload settings
Camera settings
Account settings
Modify Password
Use help
Contact us

then click the button [Use help](#) at the left setting menu in the page to open the instruction manual of the Ltl Camera Cloud System.

Note: Please refer to the detailed operation instructions of Ltl Acorn Cloud System, Ltl Acorn Cloud System mobile APP and WeChat official account in the Use help of Ltl Camera Cloud System website.

LTL ACORN®

LTL-8830 Series Products

Ltl-8830 series are the latest 4K ultra-high-definition video cameras developed by Ltl Acorn, compatible with 5G NR(4G LTE and no network version are available) cellular mobile communication, equipped with an external display.

The camera adopts high-performance image processor, 8MP sensitivity (with Nyxe technology), 120 degrees wide angle lens (60 degrees lens models optional), capable to record 4K 30FPS ultra high definition video and take high definition snapshot of 8MP, shooting range is wide, picture is clear and delicate , it records high quality night images.

7.1 Ltl-8830 series model

Ltl-8830-5G



Ltl-8830-4G



Ltl-8830 has three versions: 5G, 4G and version without wireless module. Specifically, it has Ltl-8830-5G Series, Ltl-8830-4G series, Ltl-8830M series (without wireless module):

Ltl-8830-5G

1. **Ltl-8830-5G (white light) (60 degrees lens)**
2. **Ltl-8830-5G (850nm IR Light) (60 degrees lens)**
3. **Ltl-8830-5G (950nm IR Light) (60 degrees lens)**
4. **Ltl-8830W-5G (white light) (120 degrees lens)**
5. **Ltl-8830W-5G (850nm IR Light) (120 degrees lens)**
6. **Ltl-8830W-5G (950nm IR Light) (120 degrees lens)**

Ltl-8830-4G

1. **Ltl-8830-4G (white light) (60 degrees lens)**
2. **Ltl-8830-4G (850nm IR Light) (60 degrees lens)**
3. **Ltl-8830-4G (950nm IR Light) (60 degrees lens)**
4. **Ltl-8830W-4G (white light) (120 degrees lens)**
5. **Ltl-8830W-4G (850nm IR Light) (120 degrees lens)**
6. **Ltl-8830W-4G (950nm IR Light) (120 degrees lens)**

Ltl-883M Series(without wireless module)

1. **Ltl-8830MC(White Light) (60 degrees lens)**
2. **Ltl-8830MC (850nm IR Light) (60 degrees lens)**
3. **Ltl-8830MC (950nm IR Light) (60 degrees lens)**
4. **Ltl-8830WMC(White Light) (120 degrees lens)**
5. **Ltl-8830WMC (850nm IR Light) (120 degrees lens)**
6. **Ltl-8830WMC (950nm IR Light) (120 degrees lens)**

Note: When the camera is not connected to the external display, it can only enter ON mode and OFF mode. After the camera is correctly connected to external display, turn the switch to ON and you can enter the Test mode.

IMPORTANT INFORMATION

8.1 Power Supply

Install 6pcs 18650 lithium batteries in battery box of Ltl-8830 series and connect solar panel to recharge through external power supply port. LTL-SUN-5.5W solar charger is recommended to charge 6pcs 18650 lithium batteries, which can greatly extend the working time of the camera. Depending on how the camera works, it may even work all the time, eliminating the need to change batteries.

The camera damaged by battery leakage is not covered in warranty.

8.2 Prevent From Short-Circuits

There are conductive metal contacts on camera unit and battery box, to avoid short circuit to damage the camera, please NEVER contact these conductive metal contacts with any metallic materials.



8.3 SD Card

There are various brands of SD cards on the market. We tested on our camera as many brands as we can. However, we cannot guarantee every brand will be compatible with our camera. Please format the SD card on the camera if the damaged photo is taken. If it doesn't work well, please try another brand.

8.4 Auto Adjustment on Video Length

To extend the battery life, through technological improvements, the camera can shoot 30% more video clips in video mode or video + snapshot mode than similar products on the market. When the battery power is insufficient, the camera can automatically shorten the video length, maximize the shooting of vi

deo clips. Therefore, Ltl Acorn camera can record 2 ~ 3 times more footage than similar products, providing users with more useful data.

Attention: The camera performs at extreme cold environment as low as -45°C (-49°F), in which the battery power capacity deteriorates drastically. Therefore, the number of video clips decreases accordingly.

8.5 850nm and 950nm IR LED

Ltl-8830 series cameras has 3 types of LED light for option, 850nm, 950nm and white light. The 850nm provides a maximum irradiation range of 25m, the 950nm provides a maximum irradiation range of 20m, and the white light provides a maximum irradiation range of 25m. The advantage of the 950nm infrared LED is that it is almost invisible to the naked eye in dark environments.

8.6 Mount on Tripod

The camera can be mounted on a 1/4" tripod. The detailed operation: align the bolt at the top of tripod to the screw hole on the back of battery box and tighten it, then adjust the shooting view angle of camera as request.

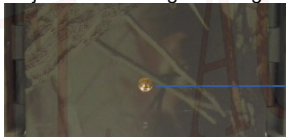





**Screw Hole on
Battery Box**

8.7 FAQs on 4G Function

- **The camera stops sending :** Please check if the SIM card balance is enough and local signal is well.
- **It takes so long to receive picture or cannot receive:** The signal is too weak or the batteries is near to be ran out.
- **Set the camera to have burst shooting, but some pictures were not sent:** The camera is able to send constantly, but if the signal is too weak, it may not work stably.
- **Receive partial image or some is incomplete:** The camera was in motion when sending pictures. Or the signal was unstable. Besides, the SD card may be damaged.

8.8 Low Battery Alert

The camera shows the battery level on each picture. When the battery level is high, the battery icon is shown as  at the bottom left corner. When the battery level gets lower, it shown as . When the battery level is continuously decreased, it will be shown as , means that it's time to replace the battery. Otherwise, when the power continues getting lower, the battery icon will be changed to  and the camera will stop working due to low power. User can replace the battery timely according to the battery level displayed on the photo sent by camera.

LTL ACORN®

Precautions

9.1 Battery safety

The camera can hold 6 18650 lithium batteries, about the use and storage of batteries, please note:

- ◆ Do not short-circuit the battery.
- ◆ Do not soak the battery in the water.
- ◆ Do not approach and place the battery in the fire.
- ◆ Do not dissect and deform the battery, avoid contacting with the skin after the battery leakage.
- ◆ Do not mix batteries of different capacity when charging and using.
- ◆ Avoid placing the battery in device that unused for a long time.
- ◆ If the battery performance drops significantly, please replace to new battery.
- ◆ The inside of the battery is toxic substance of heavy metal , it's strictly prohibited to put into mouth.
- ◆ Please keep batteries away from children.
- ◆ Do not mix and use with other different types of batteries.
- ◆ Do not connect the battery electrode incorrectly in the charger or camera.
- ◆ Please check the battery regularly and replace abnormal battery in time.
- ◆ The battery should be placed in a cool, dry and well-ventilated area.
- ◆ When charging the 18650 battery, please connect the positive and negative poles correctly, do not use retrofitted or damaged charger, do not place the battery in the charger for more than 24 hours.
- ◆ Batteries should be stored at room temperature and should be charged to 30% to 50% of electricity. If stored for a long time, it is recommended to charge the battery every six months to prevent from over discharge.
- ◆ Waste battery treatment should comply with local regulations, so as not to endanger the environment and health.

Note: 18650 lithium batteries must be charged by qualified 18650 lithium battery charger and cannot use retrofitted or damaged charger. 18650 lithium battery charging cut-off voltage is 4.2V, a single 18650 lithium battery current is about 440mA~1100mA, please do not charge it at low temperature environment.

9.2 Use Camera Outdoors

When the camera needs to work outdoors for a long time, please note:

- ◆ Properly install 6x18650 lithium batteries in camera battery

compartment.

- ◆ Switch the camera to ON mode, then connect the camera and battery compartment, clasp buckles tightly (please be careful not to hurt the hands or get stuck by foreign matter during assembly).
- ◆ Please choose straps, steel cables or brackets to fix the camera as required, strongly pay attention to fix the camera firmly to avoid falling off to hit people or breaking the camera.
- ◆ When camera works for long time, please check the camera and batteries regularly to deal with the abnormal situation in time.
- ◆ There are 42 850nm or 950nm infrared LED lights on the camera. When the infrared LED light of camera is on, please do not look at the light closely, the distance between the eyes and the lights should not be less than 1.5 meters, and please do not directly view the lights over 3 seconds, the interval between two direct viewings shall not be less than 2 hours to avoid the harm to the eyes.

FIRMWARE UPGRADES

The manufacturer reserves the right to upgrade the camera firmware and 4G module program, please consult with the local distributor for the website to download the program.

Make sure the camera with enough power before upgrade to avoid the unsuccessful upgrade or the fault caused by low battery after upgrade. Please follow below instruction to upgrade:

Prepare SD card

- Connect the SD card to computer and back up the SD card contents to computer (SD card reader may be needed).
- Retrieve the SD card from computer, insert it into camera and load batteries.
- Format the SD card on the camera.

Upgrade camera firmware

- Remove the SD card from the camera and connect to computer. Copy the camera program `upgrade_Ltlacorn-8830_1.0.0.0.20...fw` to the root directory of the SD card.
- Insert the SD card into camera, switch camera to ON mode, install the SD card and SIM card correctly, close the camera with battery box and lock the buckles, then connect the external display, turn on the camera to enter the preview test mode.
- Screen shows "Do you want to upgrade now?", press left/right button to "Upgrade", press OK button to confirm.

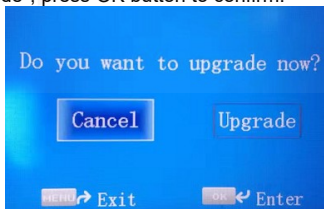

- The update percentage is on screen, 100% means update finished, camera would restart and enter TEST mode automatically.

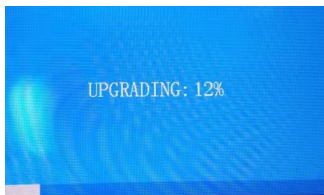

- Please set to default setting before starting using camera, the update is finished.

Attention: The upgrade program of Ltl-8830 series is not compatible to other models. If a camera is accidentally upgraded by running a non-compatible program, it will quit working and needs to be sent back for repair. This issue is not covered under warranty.

LTL ACORN®

Remote update program via Ltl Camera Cloud System

The Ltl-8830-4G or 5G camera with newly added function of remote update camera program via Ltl Camera Cloud System. The function of remote update program allows you to remotely update camera FW software.

Conditions of online update:

1. The camera send status is set to 'Ltl Camera Cloud System' and the upload parameters are set correctly.
2. Enter ON mode to ensure that the files captured by the camera are properly uploaded to the Ltl Camera Cloud System.
3. Users must login the Ltl Camera Cloud System through the browser on PC to upload the camera program.

Online Update:

In ON mode, please confirm the photo or video captured can be uploaded to Ltl Camera Cloud System successfully, then users can login the Ltl Camera Cloud System through the browser on PC and upload the program by below steps.

1. Please login Ltl Camera Cloud System through browser on PC, click











camera manage 

Cloud > Camera Manage Close

SIM Number: Search

Batch delete + Add 3/4G camera Total number of lines: 5strip

View the camera notes, mailbox information, etc., please open the edit dialog box

	Serial number	IMEI	SIM Card number	Total numbers	Camera name	current location	electricity	About working hours(h)	About working hours	Operation
<input type="checkbox"/>	1	3	185	468	A	广东省清远市清新区	Low	3433	2019-07-25 03:08:10	 
<input type="checkbox"/>	2	6	185	74	B	广东省清远市清新区	High	2785	2019-06-28 02:25:48	 
<input type="checkbox"/>	3	3	156	296	3333	广东省清远市清新区	Low	1227	2019-06-27 00:00:00	 
<input type="checkbox"/>	4	5	137	0	123	Coordinate information error, location information not found	High	0	2019-06-10 22:28:02	 
<input type="checkbox"/>	5	6	21	68	RUBBER MO NKEY	Coordinate information error, location information not found	High	241	2019-06-24 00:00:00	 

2. Find the camera that needs to be updated in the camera manage list, click the edit button  in operation line at the right side to pop up the edit window. In the window you can see the camera's current program version and the file selection buttons.

Edit ×

latitude:

Remarks:

camera model:

MCU version:

FW version:

FW upload: No file chosen

Loader version:

Loader upload: No file chosen

Modular version:

Modular upload: No file chosen

3. Click select file button at right side of FW upload, pop up the file selection box.

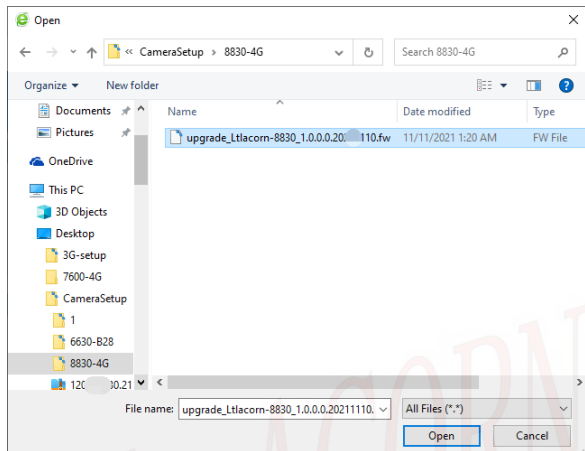

Find the camera software program ' upgrade_Ltlacorn-8830_1.0.0.0.20 .fw ' you want to update through the open file window that pops up in the browser, choose and click 'Open', you can see the ' upgrade_Ltlacorn-8830_1.0.0.0.20 .fw ' appears at the right side of choose file button;

camera model:	<input type="text" value="LTL-8830-4G"/>
MCU version:	<input type="text" value="V81"/>
FW version:	<input type="text" value="1.0.0.0.20211012"/>
FW upload:	<input type="button" value="Choose File"/> upgrade_Ltlacorn-8830_1.0.0.0.20211110:

4. Then click the confirm button below the edit window, wait patiently for about 20 seconds (the wait time is different depends on different network speed), the edit window will be automatically closed, camera program uploaded successfully.

Note: Click the confirm button below the edit window to start uploading program, during upload process, please to be patiently to wait till the window is closed automatically, do not click the confirm

button or close button  again, otherwise it will cause the upload failure.

5. After successfully upload the update program to the cloud system, when the camera records and uploads photo or video to the cloud system again, it will automatically download and save the update program from the cloud system to the camera SD card, as well as automatically update.

After the camera automatically update successfully, you can view the camera version to confirm the update is successful at camera manage→edit window.

LIMITED WARRANTY

We take great pride in our products. We always stand behind our promises. We provide leading warranty term and service. Every LTL ACORN trail camera comes with a limited times warranty.

We guarantee our trail cameras to be free of defects in materials and workmanship under normal use and service for a period of a limited time after the registered date of purchase. This warranty does not cover damages caused by misuse, abuse, or improper handling or installation, by user installed batteries, or by repair attempts of someone other than our authorized technicians.

In the event of a defect under this warranty, we will, at our option, repair your camera or replace it with the same or comparable model free of charge, provided the product is returned postage paid. This warranty only extends to the original retail buyer from our authorized dealer. Purchase receipt or other proof of the date of the original purchase is required to receive warranty benefits. The warranty on any replacement product provided under the original warranty shall be for the remaining portion of the warranty period applicable to the original product.

This warranty extends solely to failures due to defects in materials or workmanship under normal use. It does not cover normal wear of the product.

Please contact our tech support department to determine the nature of the problem before you return a LTL ACORN product under this warranty for repair or exchange.

Appendix I: TECHNICAL SPECIFICATION

Model	Parameters
Image Sensor	8MP sensor (with Nyxe technology)
Lens	FOV=120°; F=1.8;Auto IR-Cut; FOV=60°; F=1.6;Auto IR-Cut
IR Flash	6 ultra-high brightness LED lights (950nm, 850nm, white light; optional)
Night Shooting Distance	White light flashes 25 meters 850nm infrared LED flashes 25 meters 950nm infrared LED flashes 20 meters
External Button Control Box With Display Screen	2.45" ; 16.7M Color; 6 Keys
Memory Card	Support 16GB ~ 128GB (Class 10 and above), the genuine SanDisk or Kingston 32GB SD card (Class 10 or above) are recommended
Picture Size	20MP, 16MP, 12MP, 8MP, 4MP
Video Resolution	4K: 3840x2160 2K: 2560x1440
(Video+Snap) Snapshot Size	8MP、4MP; The size of snapshot is same as the video resolution.
PIR Sensitivity	High/ Normal/ Low/ Off
PIR Sensing Distance	Up to 35 meters (below 25°C at the Normal sensitivity)
PIR Sensing Angle	15~100 degrees according to the distance of the target
Operation Mode	Day/ Night
Time From Trigger to Finish Shooting	0.4 Seconds
Trigger Interval	0sec - 60min; Programmable
Photo Burst	1~3
Video Length	2~60sec ; Auto (5~32 seconds Automatic adjustment); Programmable;
Time Stamp	On/Off; Includes serial number, longitude and

	latitude, temperature, moon phase, date and time, battery power.
Timer1	On/Off; Programmable
Timer2	On/Off; Programmable
Schedule	Normal Weekly: camera works within the specified time on the set day of the week. Override Exception: set to work in the specified time of specified date.
Password	4 Digits (0~9)
Serial No.	4 digits and alphabets (0~9, A~Z)
Time Lapse	Off/ On; 0 Sec~23 Hour 59 Min 59 Sec; Programmable
Beep Sound	On/ Off
SD Cycle	On/ Off
Frequency Bands Supported by Wireless Module	5G NR wireless module: 5G NR: n1/n28/n41/n77/n78/n79 LTE-FDD: B1/B2/B3/B5/B7/B8/B20/B28 LTE-TDD: B34/B38/B39/B40/B41 WCDMA: B1/B2/B5/B8 4G LTE wireless module: B1/B2/B3/B5/B7/B8/ B28B40/850/900/1800/1900MHZ
Wireless Transmission Speed	5G NR the maximum uplink speed reaches 50Mbps ; 4G LTE the maximum uplink speed reaches 50Mbps;
SMS Remote Control Interval	The interval to receive SMS could be set as 10 minutes and 1 to 24 hours.. For example: set interval as 1 hour, send the text of command 60/61 or 62 on mobile, camera can receive SMS command and transmit the image file within 1 hour. The module normally cuts off the power and does not consume power, it will work after camera shooting and then transmit the image file.
Function of Immediate Transmission of Original Image	Send image to the preset receiving end immediately after finishing shooting.

Remotely Modify Camera Parameters Intensively	Set the camera parameters and remotely modify on the Ltl Camera Cloud System: when the camera uploads images to the Ltl Camera Cloud System, it reads the parameter settings generated by the Ltl Camera Cloud System and takes effect at next time when the camera works.
Wireless Send Options	Email, FTP, SFTP, Ltl Camera Cloud System, Off=doesn't send file to E-mail, FTP, SFTP, Ltl Camera Cloud System; programmable: Send picture and video, no limited size of video file, a video of 60s is about 120M usually.
Email Recipient E-mail Address	1~2 E-mail Addresses
Sender E-mail	1 Sender E-mail Address
Remote Control	1 Remote Recipient Phone Number, 1 Remote Receiver E-mail
Recipient FTP Setting	1 FTP Server Setting
Recipient SFTP Setting	1 SFTP Server Setting
Ltl Camera Cloud System	It has the functions of receiving and managing image files, identifying common animal species, setting the parameters of the Ltl Camera Cloud System, and displaying the actual position of camera on the map, etc.
Ltl Camera Cloud System APP	Use the Android/iPhone Ltl Camera Cloud System APP to visit Ltl Camera Cloud System on mobile.
Environmental monitoring (optional)	After the camera is connected to the environmental data acquisition detector, the ambient temperature and humidity and intensity data can be collected and uploaded to the Ltl Camera Cloud System.
Power Supply	6 x 18650 Lithium Battery
External DC Power Supply (optional)	Plug Size: 4.0mmx1.7mm DC charging voltage: 12V~24V (DC power supply standard of customized camera: 7.4V~8V, 1~2A)

Solar panel charging (optional)	LTL ACORN weak light solar panel can be used to charge the rechargeable battery in the camera, saving energy and the battery can work for long time without changing. (12V~24V)
Standby Current	90uA(non-sleep state)
Standby Time	3 years (6 x 18650 Lithium Battery)
Auto Power Off	Auto power off in 4 minutes without any operation in TEST mode.
Power Consumption	280mA(+670mA when 950nm IR LED up; +600mA when white light or 850nm IR LED up)
Interface	Type -C socket; SD Card Slot; SIM Card Slot; DC External;
Mounting	Strap; Tripod;
Ingress Protection	IP68
Working Temperature	-45°C ~ +70°C
Working Humidity	5% ~ 95%

Appendix II: PACKAGE CONTENTS

Part name	Quantity (PCS)
Digital Camera	1
External Button Control Box With Display Screen(optional)	1
Environmental Data Detector(optional)	1
Strap	1
External DC Power Cable (Optional)	1

Note: External display is optional for purchase, user can decide buy or not, 3.7V 18650 lithium battery should be bought locally by buyer.

Appendix IV: Place and Install Camera

1、 Mount on tripod

There is a 1/4" nut hole on the back of the camera battery box, fix the camera to tripod by screw up the nut, and then adjust shooting angle.

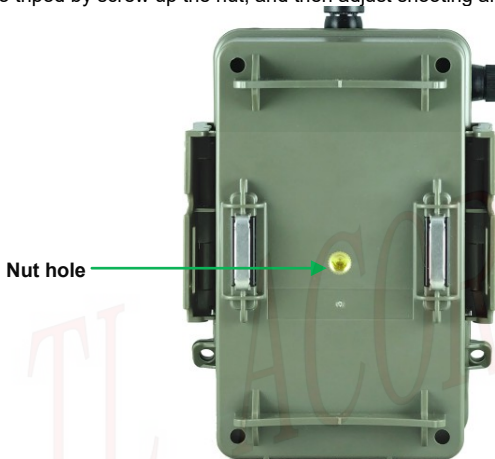

2、 Mount on tree trunk

Across the theft proof holes at the side of the battery box with a cable lock, mount the camera on tree trunk.

Besides, to avoid camera being stolen and damaged, use a chain and lock to keep it safe if possible.

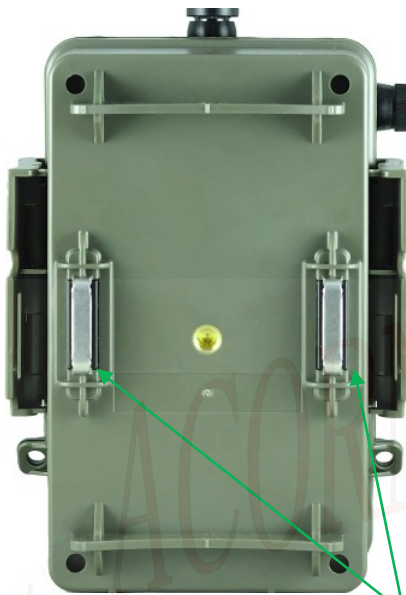

Cable hole